

**DESIGN GUIDELINES FOR ABC COLUMN-TO-DRILLED-SHAFT
FOUNDATION CONNECTIONS IN HIGH SEISMIC ZONES**

**Quarterly Progress Report
For the period ending August 31, 2021**

Submitted by:
PI: Marc Eberhard
Co-PI: John Stanton
Research Assistant: Michelle Chang

**Affiliation: Department of Civil and Environmental Engineering
University of Washington**



**ACCELERATED BRIDGE CONSTRUCTION
UNIVERSITY TRANSPORTATION CENTER**

Submitted to:
ABC-UTC
Florida International University
Miami, FL

1. Background and Introduction

Precast columns have the potential to be very cost- and time-efficient for ABC, but they must be connected effectively to the foundation, particularly in regions of moderate or high seismicity. Most of the relevant research on column-to-foundation connections has been conducted for spread footings, but drilled shafts (most commonly with a diameter larger than that of the column) are preferred in many applications. Little research has been performed on the seismic performance of connections between precast columns and enlarged drilled shafts.

Discussion with the Washington State Department of Transportation (WSDOT) and California Department of Transportation (Caltrans) indicate that drilled shaft foundations are being used with increasing frequency for bridges. Drilled shafts are often needed to support a bridge when the soil conditions, or limited space, make it difficult or impossible to use spread footings. Speed and simplicity of construction, which are essential to ABC, require adequate construction tolerances, and these are most easily achieved if the shaft diameter is larger than that of the column.

2. Problem Statement

The current AASHTO ABC design recommendations for shafts are based on the results of cast-in-place column behavior and a single cyclic test of a column-to-shaft subassembly. This research uses experimental data from a past study (Fig. 1) and data from a PEER-funded study to calibrate strut-and-tie and/or finite-element models of connections between precast columns and cast-in-place drilled shafts. The calibrated models will be used in a parametric study, whose results will make it possible to develop design recommendations for such connections.



Figure 1. Tran Tests of Connection Between Precast Column and Enlarged Drilled Shaft

3. Objectives and Research Approach

UW researchers will develop guidelines for the design of ABC connections between precast columns and enlarged, cast-in-place drilled shafts in seismic regions. These guidelines will be

based on the results of three tests conducted previously (Tran 2015), and one additional new test conducted with PEER funding. The team will perform a parametric study using strut-and-tie models and/or finite-element models, which will have been calibrated with the test results, to consider a wider range of column and shaft properties.

4. Description of Research Project Tasks

The following is a description of tasks carried out to date.

PEER –Funded Research.

The PEER-funded research has been completed.

An additional test of a column-to-drilled shaft connection was performed with the support of the Pacific Earthquake Engineering Research center (PEER). These tests were delayed by laboratory delays due to Covid-19, but the laboratory is now open for research. During the Summer of 2020, graduate student researcher Michelle Chang constructed some of the formwork and reinforcement cages for her specimen. Figures 2, 3 and 4 shows photos of the specimen under construction.



Figure 2. Photo of Shaft and Base Reinforcement



Figure 3. Photo of Shaft Reinforcement and Cast Base



Figure 4. Photo of Column Reinforcement Cage

During Autumn of 2020, the specimen construction was completed, and the column of the test specimen was subjected to a constant axial load and cyclic, lateral displacements. Figure 5 shows Ms. Chang in front of her specimen at the end of the test. Figure 6 shows the damage to the column-to-drilled-shaft connection. The failure mode consisted of bursting of the top of the drilled shaft near the bottom of the columns.



Figure 5. Photo of Connection Specimen and End of Testing

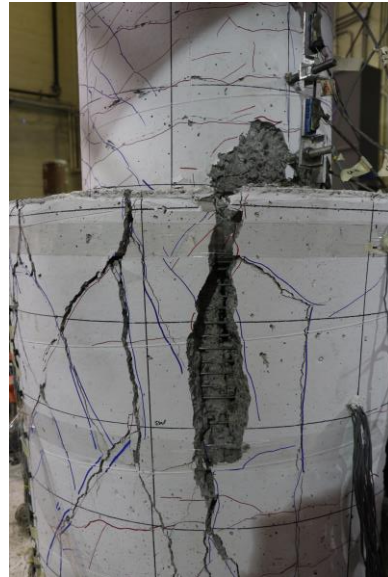

Figure 6. Photo of Damage to Drilled-Shaft Connection

Task 1 – Analysis of Data from Tran Tests and New Test.

Task 1 has been completed.

All of the data collected by Tran (2015) was preserved, but it was necessary to re-analyze the data, so that the data processing methodology for the previous tests will be consistent with that used for the new, PEER-funded tests. This analysis also made it possible to design the new test specimens so that they would be most useful in developing new design recommendations.

Researcher Michelle Chang reproduced the calculations performed by Hung Tran for specimens DS-1, DS-2, DS-3, and in a few cases, she corrected errors in the earlier data analyses. These analyses were used to select an additional specimen to test (DS-4). In addition, the research team identified an additional test that was performed recently at the University of California, San Diego. The additional data will be integrated into Michelle Chang's analysis framework.

During the first quarter of 2021, Ms. Chang analyzed the measured data from test DS-4, so that the research team can understand its behavior and compare the performance of the most-recently tested specimen with those tested earlier by others.

Figure 7 shows the measured overall force-displacement response for specimen DS-4. The specimen developed the full column flexural strength at a lateral displacement of about 1 inch, and it maintained its peak resistance until a top displacement of approximately 4-5 inches.

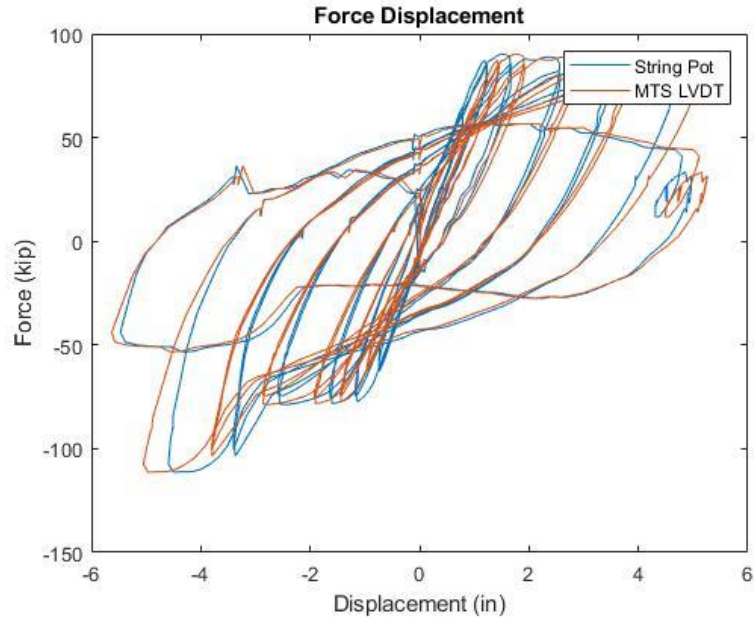

Figure 7. Overall Force-Displacement Response for Specimen DS-4.

The proportioning of the transverse reinforcement in the drilled shaft is a critical design consideration, because this reinforcement resists the splitting failure shown in Fig. 6. Figure 8 shows the vertical distribution (0 in. corresponds to column-shaft interface) of measured strains in the shaft transverse reinforcement for three levels of drift ratio (1%, 2% and 3%). Separate curves are shown for the North-Face Tension (NT), North-Face Compression (NC), South-Face Tension (ST), South-Face Compression (SC) and East-Face (E).

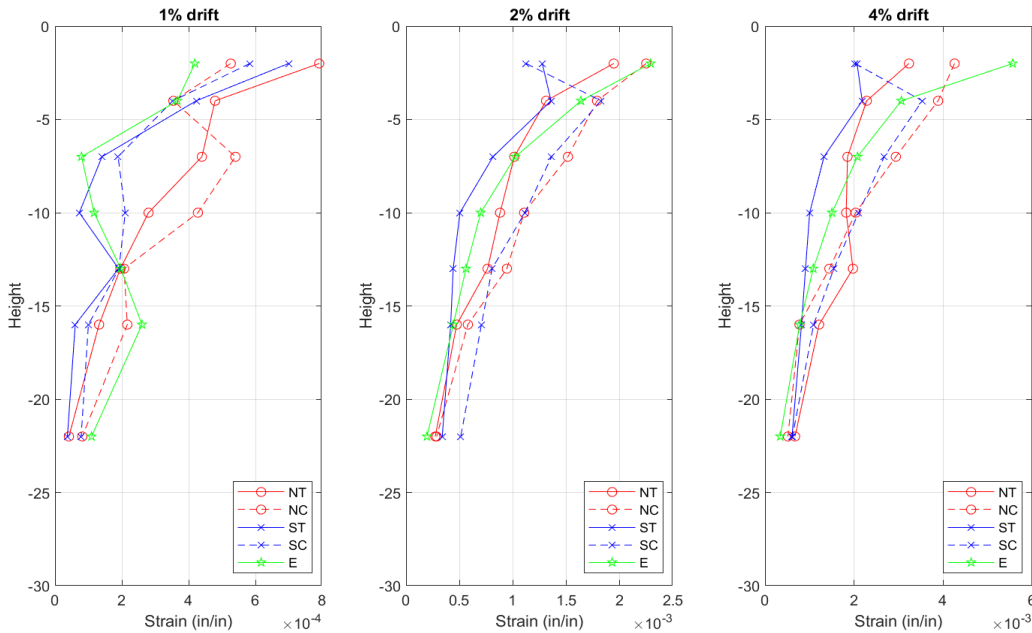

Figure 8. Vertical Distributions of Transverse Reinforcement Strains.

Figure 8 supports the following conclusions:

- The distribution of strains over the height of the drilled shaft is approximately parabolic.
- The transverse reinforcement at the top of the shaft yielded (~ 0.0022) at a drift ratio near 2%. The strains at a drift ratio of 4% were roughly double those at a drift ratio of 2%.
- At larger drift ratios (above 1% or so), the transverse reinforcement strains tended to be largest on the compression side, of intermediate magnitude on the “unloaded” East side, and smallest on the tension side.

During Spring 2021, the experimental data from the recent DS-4 test was compared with the data available from previous DS-1, DS-2 and DS-3 tests (Huang 2015). Figure 8 shows photographs of the damage of the four specimens at the end of testing. The damage to specimens DS-1 and DS-3 consisted of flexural damage at the base of the column, which is the desired behavior. In contrast, DS-2 and DS-4 failed in the shaft, an undesirable failure mode.



DS-1



DS-2



DS-3



DS-4

Figure 9. Photographs of Specimen Damage at End of Testing.

Figure 10 shows how the variation of the maximum transverse strain in the shaft reinforcement varies with the imposed drift ratio for the four DS specimens. The transverse strains increase much more rapidly in DS-2 and DS-4 than in DS-1 and DS-3. These differences in measured strains are consistent with observed damage in the four specimens.

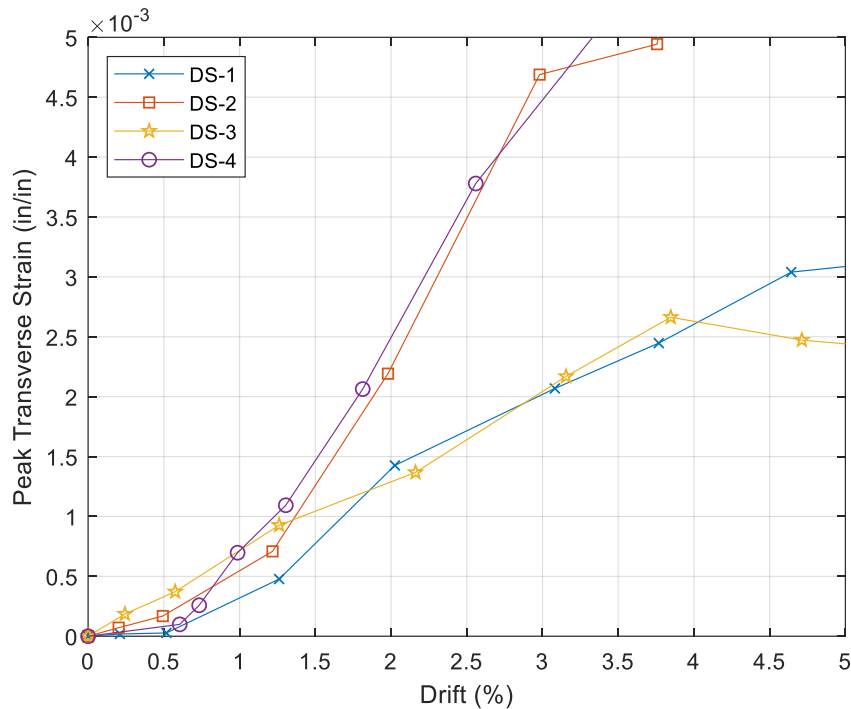

Figure 10. Variation of Strains in Shaft Transverse Reinforcement with Drift Ratio

Task 2 – Development/Calibration of Analytical Models

Task 2 has been completed.

A strut-and-tie models was developed and calibrated to be consistent with the observations and data available from Tran (2015), the PEER-funded tests, and the results of four specimens tested at the University of California, San Diego, C. Figure 11 shows the final form of two strut-and-tie models that produces consistent results. The model on the left governs when shear forces are relatively high compared to the bending forces. The model of the right governs when bending forces govern the behavior.

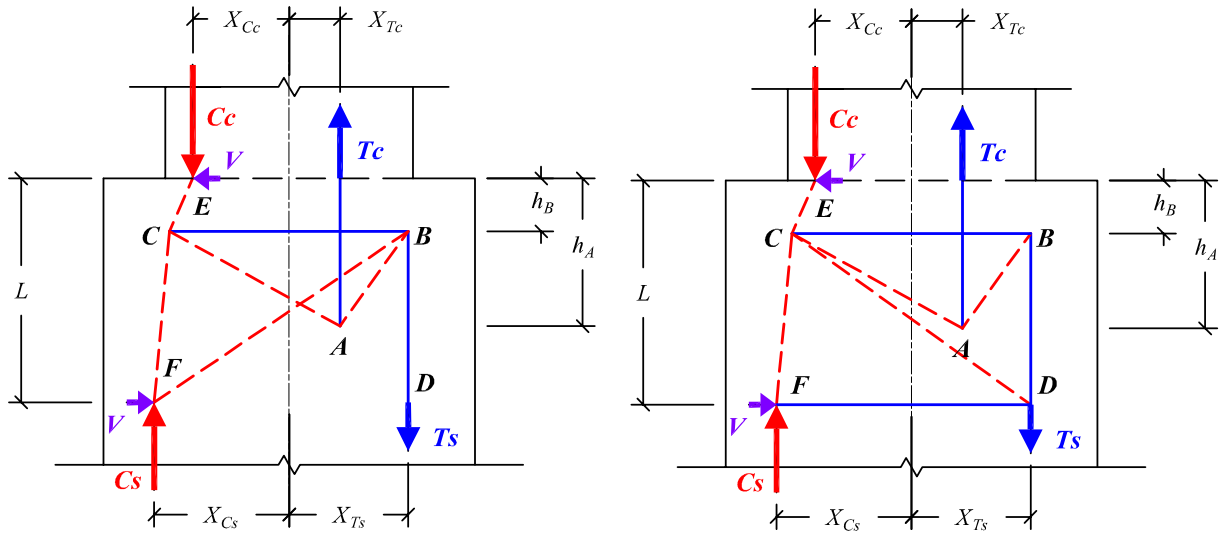
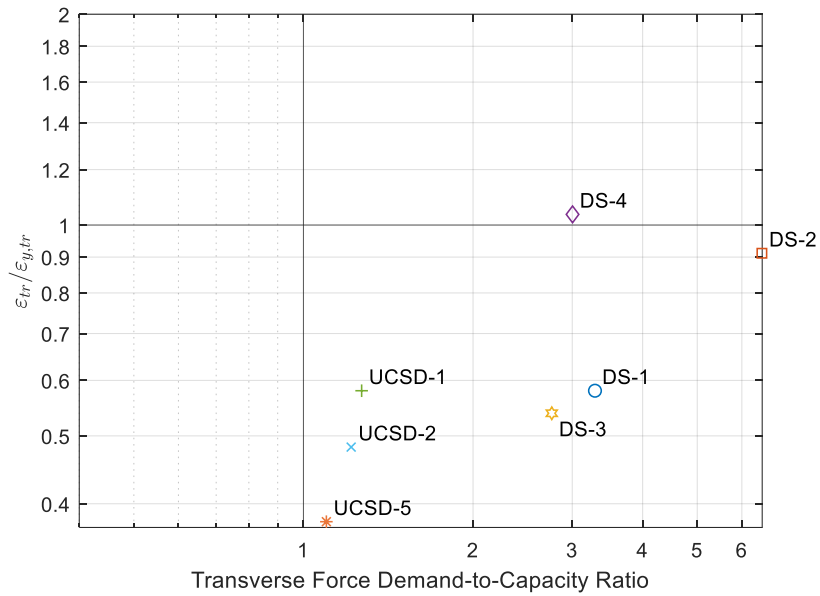
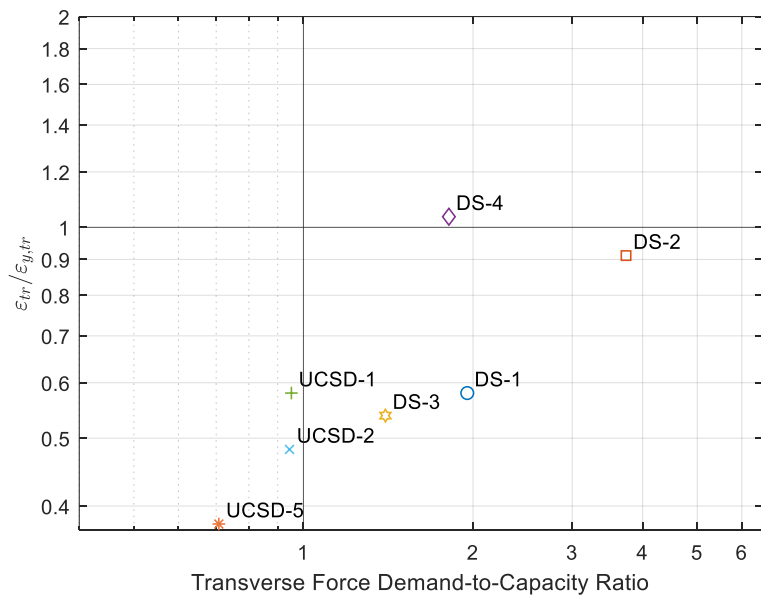

Figure 11. Strut-and-Tie for Column-to-Shaft Connection

Figure 12 shows the evaluation of the two strut-and-tie models against the experimentally measured performance. Both plots show the maximum strain in the transverse reinforcement at a drift ratio of 2% (normalized by the yield strain) versus the demand-to-capacity ratio computed using the strut-and-tie methodology. The top plot shows the results for a model that assumes that the connection carries some of the applied shear through the concrete (V_c). The bottom model assumes that some of the lap-splice transfer includes a concrete component too (T_c). The second model agrees better with the measured results, but the use of a T_c term would depart greatly from existing practice.



(a) *Strut-and Tie Model with V_c Term*



(b) *Strut-and Tie Model with V_c and T_c Terms*

Figure 12. Evaluation of Strut-and-Tie Models

Task 3 – Parametric Study

25% of Task 3 has been completed.

The strut-and-tie model is being used in a parametric study to evaluate the effects of key design variables, including the depth of embedment of the precast column, as well as the relative diameters of the column and shaft.

The results of this parametric study will be used to evaluate the simpler design model, which is being developed as part of Task 4.

Task 4 – Development of Design Recommendations

50% of Task 4 has been completed.

The researchers have developed simpler design recommendations that have been compared with the experimental results. The simpler methodology will also be compared with the results of the strut-and-tie model parametric study, described in Task 3.

These recommendations will be reviewed by bridge engineers from California and Washington states to verify that the form is appropriate for design practice.

5. Expected Results and Specific Deliverables

The main deliverable will be a report that summarizes:

- Results of the parametric study,
- Calibrated models of the connection, and
- Design recommendations.

6. Schedule

Progress of tasks in this project is shown in the tables below.

Item	% Completed
Percentage of Completion of this project to Date	90%

Table 1. Schedule

Research Task	2020								2021											
	M	J	J	A	S	O	N	D	J	F	M	A	M	J	J	A	S	O	N	
Task 1 – Analysis of New and Tran Test Data.	■	■	■	■	■	■	■	■	■	■	■	■								
Task 2 – Development of Analytical Models	■										■	■	■	■	■					
Task 3 – Parametric Study																■	■			
Task 4 – Development of Design Recommendations																■	■	■	■	
	■								Work Performed											
	■								Work to be Performed											