

# **TSUNAMI DESIGN FORCES FOR ABC RETROFIT**

**Quarterly Progress Report  
For the period ending February 28, 2022**

Submitted by:  
PI- Marc Eberhard  
Co-PI – Michael Motley  
Graduate Student- Nicolette Lewis

**Affiliation: Department of Civil and Environmental Engineering  
University of Washington**



**ACCELERATED BRIDGE CONSTRUCTION  
UNIVERSITY TRANSPORTATION CENTER**

Submitted to:  
ABC-UTC  
Florida International University  
Miami, FL

## 1. Background and Introduction

The catastrophic damage that tsunamis cause to coastal communities is often exacerbated by the destruction of much of the transportation infrastructure (Fig. 1). This destruction delays critical rescue efforts and economic recovery.

Many components of the transportation infrastructure can be damaged by the incoming tsunami bore. Additional damage can be caused by the flow of water after the initial tsunami impact, at which time the water is often carrying debris from other structures from structures located nearer the coast (incoming flow) and structures further from the coast (outgoing flow).



*Figure 1. Ponulele Bridge Destroyed by 2018 Tsunami*

## 2. Problem Statement

The effects of the initial tsunami bore on bridges has been studied analytically and experimentally by a number of researchers. For example, with funding from FHWA and five state DOTs, PEER is currently coordinating a study in which the impact of a tsunami bore on a bridge superstructure was simulated experimentally at the NHERI wave flume at Oregon State University (OSU).

Our proposed research focuses on later, post-bore effects of tsunamis, which can be equally damaging but have rarely been studied. The post-bore effects are dominated by quasi-steady-state, debris-laden flows that cannot be simulated experimentally well in a flume with a transient, piston-generated wave. No data is available to calibrate design or simulation models for this condition. Such data is needed to develop ABC methods for the retrofit of bridges to resist tsunamis.

### 3. Objectives and Research Approach

UW and OSU researchers generated an initial set of data using the OSU wave flume. As shown in Fig. 2, the force history (shown for an elevated structure) generated by debris includes multiple impacts (sharp peaks in force history) and an accumulation of force as the debris increases the hydraulic area of the bridge. The forces decrease rapidly with time, because the transient wave lasted only a short time.

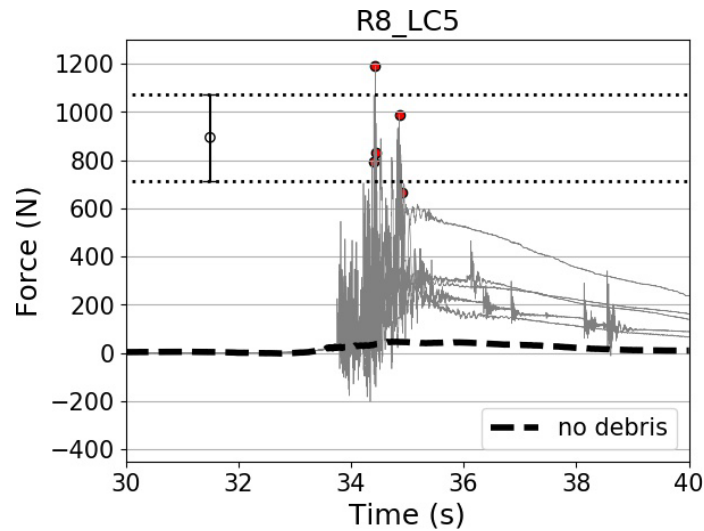

Figure 2. Measured Forces on Elevated Structure

Fig. 3 shows that the total measured force increased with the number of debris in the flow. For eight blocks, this figure also shows that the total force varied greatly among the repetitions, a behavior that is consistent with the semi-chaotic nature of debris interaction with the bridge. This dataset is available from the NHERI DesignSafe data repository (PRJ-1709: NHERI Debris Impact Experiments).

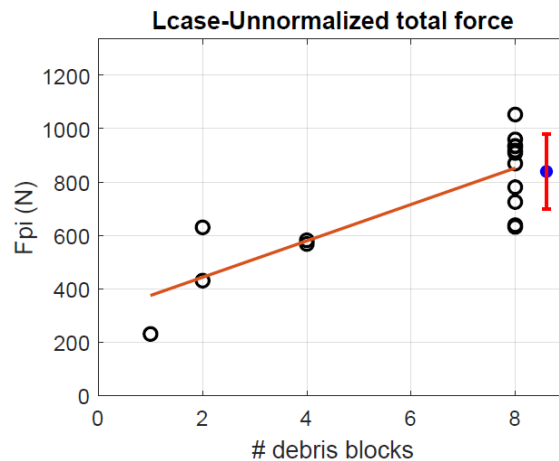

Figure 3. Effects of # Debris on Measured Peak Force

The ongoing research takes advantage of a new wind-wave-current interaction testing facility at the University of Washington. This 18-m long by 1.2-m high by 0.9-m wide facility generates currents with a centrifugal pump that enables quasi-steady flow conditions at a maximum velocity of 1.0 m/s for at maximum depth or 2.0 m at half depth. Many structures do not experience impact from the wave front of a tsunami; this facility can be used to model the accumulation of debris, and the effect of rising flows on bridges.

The experiments will create datasets that be used to develop and calibrate design and numerical models that account for flow-structure interaction, rising flow, and debris-induced forces.

#### 4. Description of Research Project Tasks

The following is a description of tasks carried out to date.

##### Task 1 – Prepare for Tests.

##### Task #1 is 100% Complete

Establish forces for reference (no debris) flow conditions as a function of fluid velocity and depth, and design test structure, support frame and instrumentation.

The fabrication of the test structure was completed earlier this year, and last quarter we purchased the data acquisition hardware needed to collect and store the test data. Figure 4 shows an isometric view of the test structure.

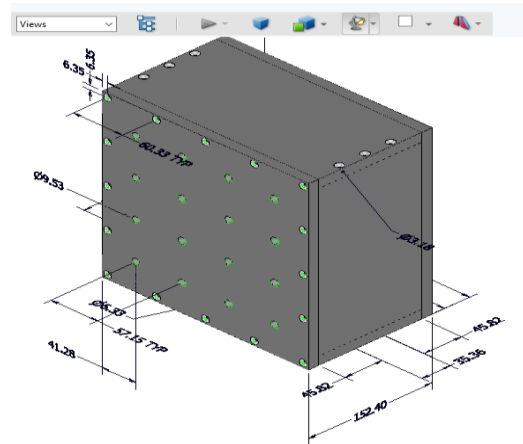

Figure 4. Drawing of Test Structure

Figure 5 shows a 3D rendering of the test setup, in which the current flows from left to right. The structure (shown in grey in middle of image) consists of a waterproof box (fabricated by Mechanical Engineering Department Machine shop), which has attachments to accommodate a wide range of column numbers, locations and heights. The specimen is connected through a 6-degree-of-freedom load cell to a supporting frame (shown as vertical I-beam downstream box). The rendering also shows (in orange) a debris field approaching the structure. The blue cylinders depict ultrasonic gages to

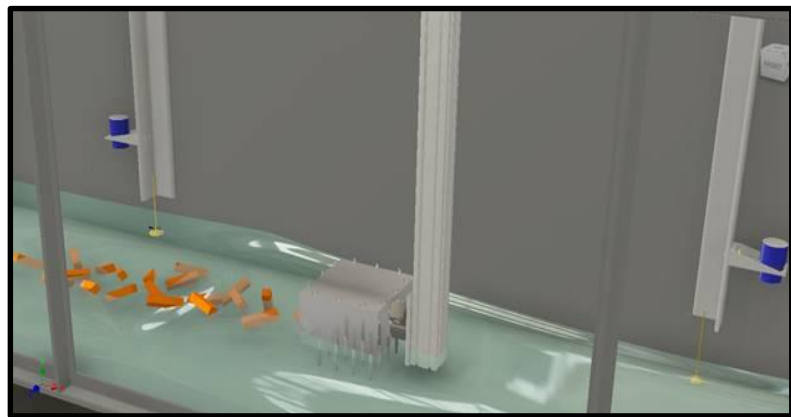
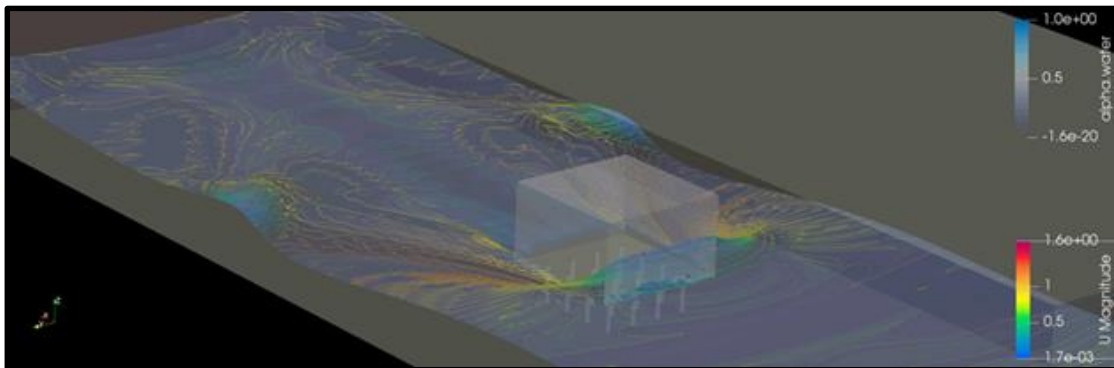

Figure 5. 3D Rendering of Test Setup

measure the elevation of the water upstream and downstream of the structure. These instruments are also supported on their own frames, which attach to the walls of the flume. During the experiments, we will also use existing (and expensive) velocimeter instrumentation to measure current velocity.

To help estimate likely the magnitudes of forces expected in the tests, the team performed 3D simulations using the OpenFoam simulation software (<https://openfoam.org>). Figure 6 shows the results of a simulation of the fluid flow around the structure for the case in which debris is not present.



*Figure 6. Typical Results of Simulation*

The test setup has been assembled outside of the flume (Figure 7). The next step will be to calibrate the 6-DOF load cell before testing can begin in the WASIRF facility.

## **Task 2 – Conduct Tests**

### **Task #2 is 100% Complete**

Measure statistical distributions (at least 20 repetitions of each test) of impact and damming forces for numerous combinations of debris and flow characteristics.

Initially, we might guide the debris with wires, so that the debris orientation can be controlled. Later (and more numerous) tests will start debris fields with a particular configuration but then allow the debris to reconfigure themselves as they approach the bridge. The main variables will be: (1) free-field flow depth, (2) free-field flow velocity, (3) # of debris/min., (4) debris shape, and (5) debris orientation.

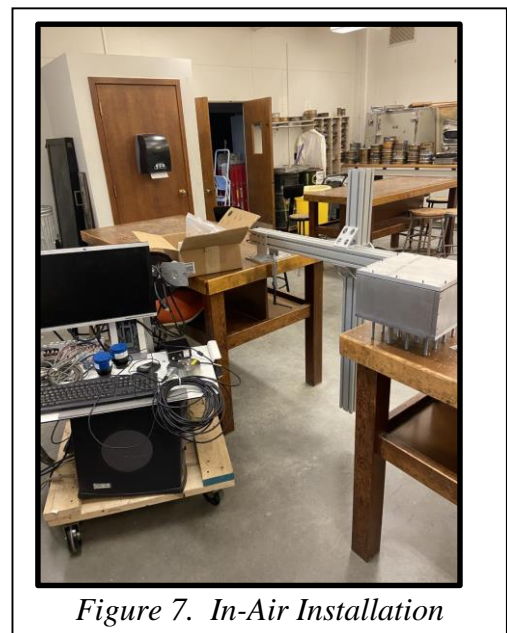

*Figure 7. In-Air Installation*

After long Covid-induced delays, the hydraulic laboratory is now available for experimental testing, and the testing began in the second week of August. It should continue until the end of the month and early September. Figure 8 shows three photographs of the test setup in the flume,

including an elevation of the test setup, a top view of the test setup, and the data acquisition system.

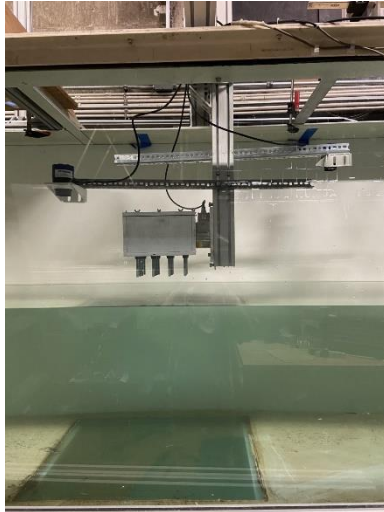

(a) Elevation of Test Setup



(b) Top View of Test Setup

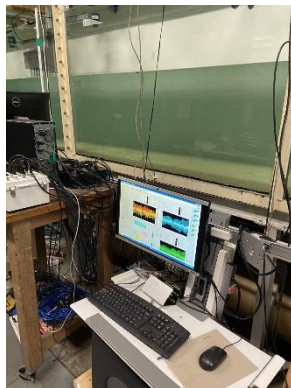

(c) Data Acquisition System

*Figure 8. Test Setup in Hydraulic Flume*

**Task 3- Develop and Document Design Tools.**

**Task #3 is 100% Complete**

The data has been collected and has been analyzed. The collected data was not sufficient to develop reliable design tools.

**Expected Results and Specific Deliverables**

It appears that the data will be good enough to support several general recommendations, which will be presented in the final report next quarter. However, it is unlikely that this \$10k project will result in detailed design recommendations.

**Schedule**

Progress of tasks in this project is shown in the tables below.

Item	% Completed
Percentage of Completion of this project to Date	85%

Table 1. Schedule

Research Task	2019	2020	2021	2022					
				J	F	M	A	M	J
1. Prepare for Tests									
2. Conduct Tests									
3. Develop and Document Design Tools									
Completed									
Planned									