

# ROBOTICS BRIDGE CONSTRUCTION: EXPERIMENTAL PHASE 1

**Quarterly Progress Report  
For the period ending August 31, 2023**

Submitted by:  
Ali Javed, Research Assistant  
Islam Mantawy, Ph.D., Research Assistant Professor  
Atorod Azizinamini, Ph.D., PE., Director of ABC-UTC

Graduate Student: Ali Javed

**Affiliation:** Department of Civil and Environmental Engineering  
Florida International University  
Miami, Florida



ACCELERATED BRIDGE CONSTRUCTION  
UNIVERSITY TRANSPORTATION CENTER

Submitted to:  
ABC-UTC  
Florida International University  
Miami, FL

## **1. Background and Introduction**

Robotics and Automation are widely used in several industries such as automobile, electronics, and aerospace mainly due to the nature of their massive production and design standardization. Unlike other industries, construction industry leaders are reluctant to integrate automation and robotic applications in their construction techniques due to unsuitability of most current conventional design to the available automation and robotics applications; the nature of large scale construction activity; material limitations; managerial concerns; and the lack of comprehensive proven research findings and guidelines related to robotics and automation in construction field. Many challenges are associated with current robotics and automated techniques such as limitations in developed 3D-printed materials; the inability of most developed 3D-printed materials to sustain standard structural loading; and challenges of 3D-printing with reinforcement which is essential for structural elements to achieve the designed capacity. In ABC-UTC we proposed a step forward toward automating bridge construction “Robotic Bridge Construction” by constructing and experimentally testing bridge elements made through robotics and automation. This project is the second phase of the ongoing project of “Robotics and Automation in ABC Projects: Exploratory Phase- ABC-UTC-2016-C2-FIU05”. In the exploratory phase, the PIs are identifying suitable materials, ultra-high-performance concrete”, suitable robotic systems “mobile robot and 3d-printing system”, and suitable prefabricated bridge elements “UHPC shells for bridge columns and beams”.

## **2. Problem Statement**

Advances in automation and robotics in manufacturing industries are not comparable to the construction industry due to the unsuitability of such approach to the current design and construction techniques, the customized structure elements and connections, and the limitation in materials to be used is automated construction. The task of constructing bridge elements have several challenges including the material strength, bond strength in between layers, flexibility, mobility and adaptation of reinforcement which will be addressed in this project.

## **3. Objectives and Research Approach**

The main objectives of this project are:

- 1- Material level testing for the proposed UHPC design mixture for automation. The material selection is being developed under the exploratory phase of this project.
- 2- Construction of UHPC shell for beams and columns using automated systems or robot which are both developed under the exploratory phase.
- 3- Large scale testing of the robotic bridge elements (UHPC shells for beams and columns) and comparison with those constructed using conventional construction.

4- Preliminary investigation on robotic and automated construction for repair and retrofit for field application.

## 4. Description of Research Project Tasks

Figure 1 shows the proposed project flowchart for the assembly of 3D printer.

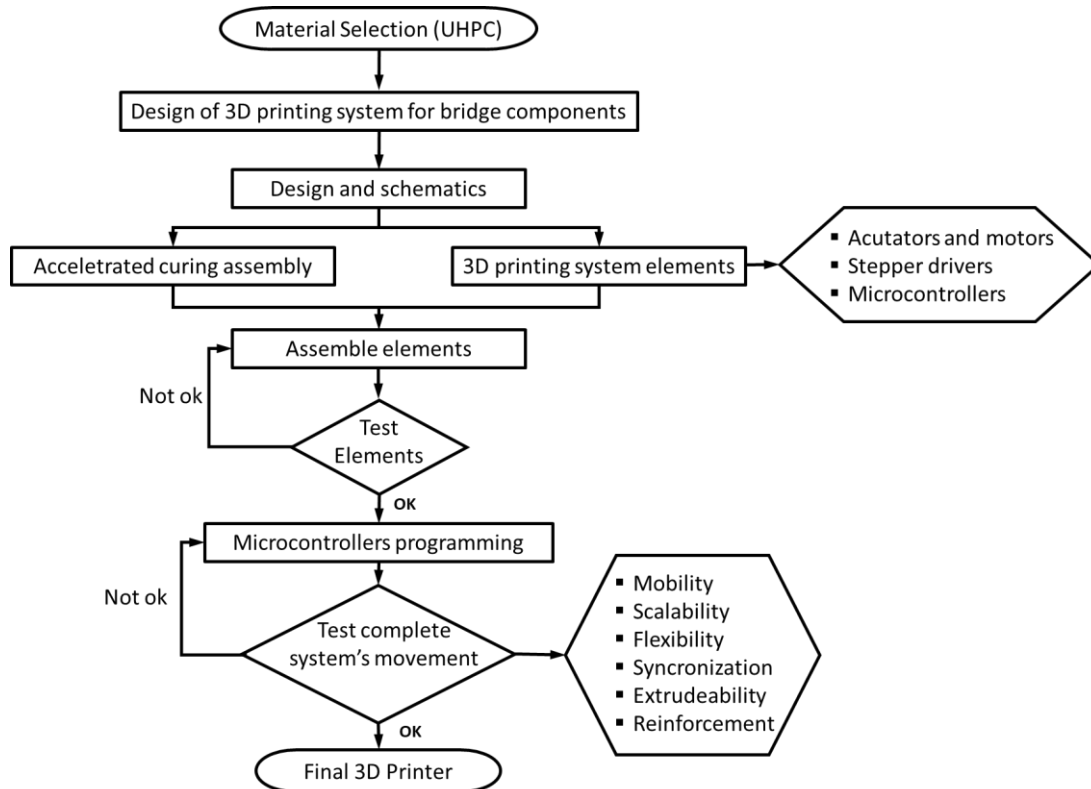

Figure 1: 3D Printer Assembly Flowchart

### Task 1 – Verification of Exploratory Phase Results

Under this task, verification of the results from the exploratory phase for both material selection and robotic systems will be conducted and iterated to ensure the logistics of constructing UHPC shells for bridge columns and beams.

*Progress: This task is 100% complete. The UHPC constituents were finalized from the exploratory phase to construct UHPC shell formworks. The components to construct 3D printer has already been selected and purchased to make the final assembly. These components include a system which can 3D print large scale UHPC shells of different shapes.*

### Task 2- Robotic Construction for Material Testing

In this task, material testing for the proposed design mixture for UHPC is conducted. The material testing is conducted for specimens cast regularly such as UHPC cylinders for both compression

and modulus of elasticity tests, dog-bone test for tensile strength, and small beams for flexural tests. The material level test will also include specimens cast using robotics and automation such as UHPC cubes for compression tests. This step is important to verify the mechanical properties of the used mixture and the effect of the automation on the mechanical properties in case of using heated print heads.

*Progress: This task is complete. After the selection of material, a small UHPC wall was printed and checked to ascertain properties like buildability, constructability and open time between layers for the large specimen. Several different ultra-high-performance concrete (UHPC) mixes were used and tested to obtain proper workability for the 3D-printing using flowability test as per ASTM C1437 as shown in **Figure 2**. The material was heated to obtain the properties like open time and buildability in 3D-printing so it was essential to verify the mechanical properties of the material. The heating of the material was done by using strip heaters as shown in **Figure 3** and then specimen was cut into cubes to check the strength properties as shown in **Figure 4**. It was also verified through compression testing that the material obtained the required compressive strength (>15ksi) after heating at optimum temperature.*



**Figure 2:** Workability of the material using flowability test (ASTM C1437)



**Figure 3:** Material Heating



Samples Preparation



Compression test of cubes

**Figure 4: Material testing**

*The complete printing assembly has already been designed and the assembly parts have been procured to build the 3D printer for large scale specimen by using a mobile raptor track drive programmed to print different shapes. Initially, a small wall is 3D printed in small segments and multiple layers as shown in **Figure 5**. After performing important tests to verify mechanical properties like compressive strength and bond strength between layers, the complete UHPC shell beam cap will be printed under this task.*

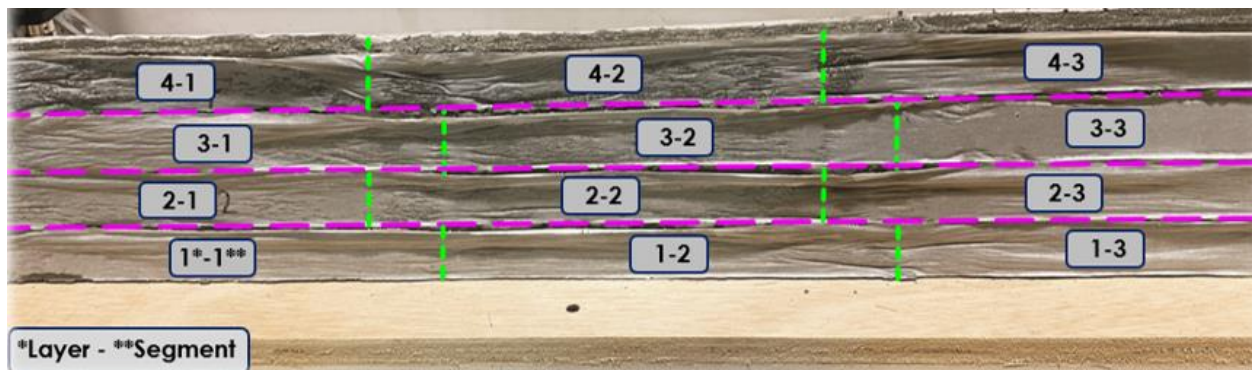

**Figure 5: 3D printed UHPC wall**

### **Task 3– Robotic Construction for Large Scale Specimens**

In this task, robotic construction will be used to prefabricate UHPC shells that act as stay-in-place formwork. The prefabricated UHPC shells using robotic construction will include beam and column specimens similar to those tested previously using conventional formwork.

*Progress: This task is also complete. The trial 3D-printing of large scale beam shell was conducted in lab. The system was developed with the use of multiple heating plates controlled with PID's and relays. Furthermore, the conceptual diagram of the large robot is shown in **Figure 6**. The main framing assembly connected with actuators is mounted on the rapter track drive. The working procedure of the proposed 3D printer in shown in **Figure 7** in five steps. The temperature of inner*

plates is kept higher as compare to the temperature of outer plated so that a better bond strength can be achieved after moving the printing head to print the next segment. The heating time before moving the nozzle using actuators was kept as 40 minutes. The total printing time to 3D print 12-inch-long wall was 2 hours.

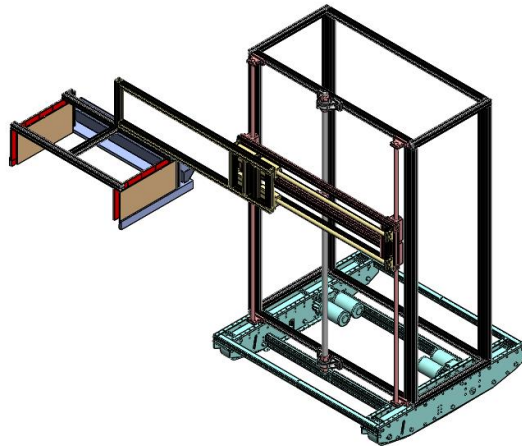

**Figure 6:** Conceptual diagram of large scale UHPC 3D-printer

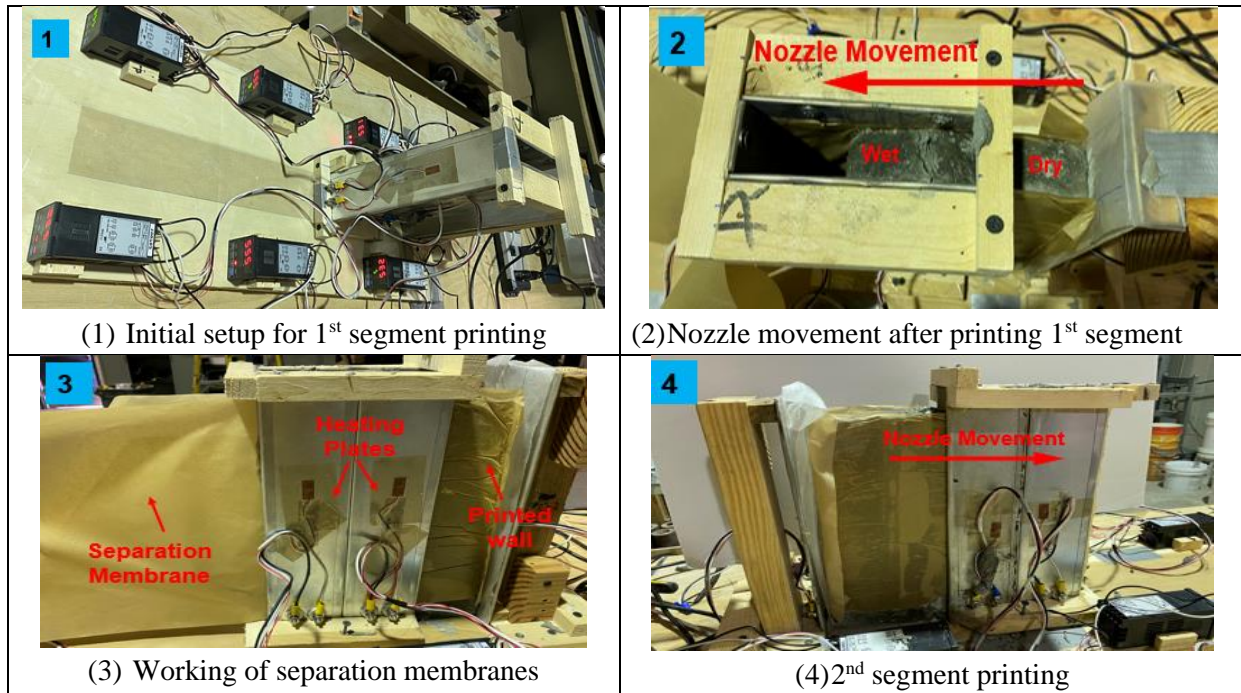

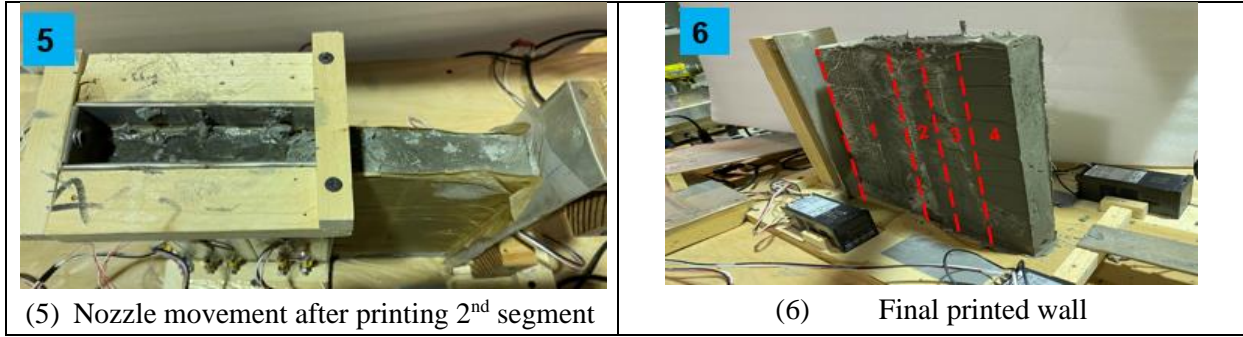

**Figure 7:** Segment 3D printing working procedure

*A 8 feet long beam section was 3D printed by utilizing the above concept and with the assembly shown in **Figure 8**. The printed section of the beam is shown in **Figure 9**. The beam was printed in 20 segments each 5 inch wide. The wall thickness of UHPC is 1.5 inch and the floor thickness of the beam shell is 2 inch. The height and width of the beam shell is 12 inch and 13 inch respectively. During 3D printing, the temperature of inner heating plates is 125°F and the outer heating plates is 100°F. The heating time for each segment is 25 minutes so with continuous supply of the UHPC mix, it will take approximately 9 hours to print 8 feet long beam section.*

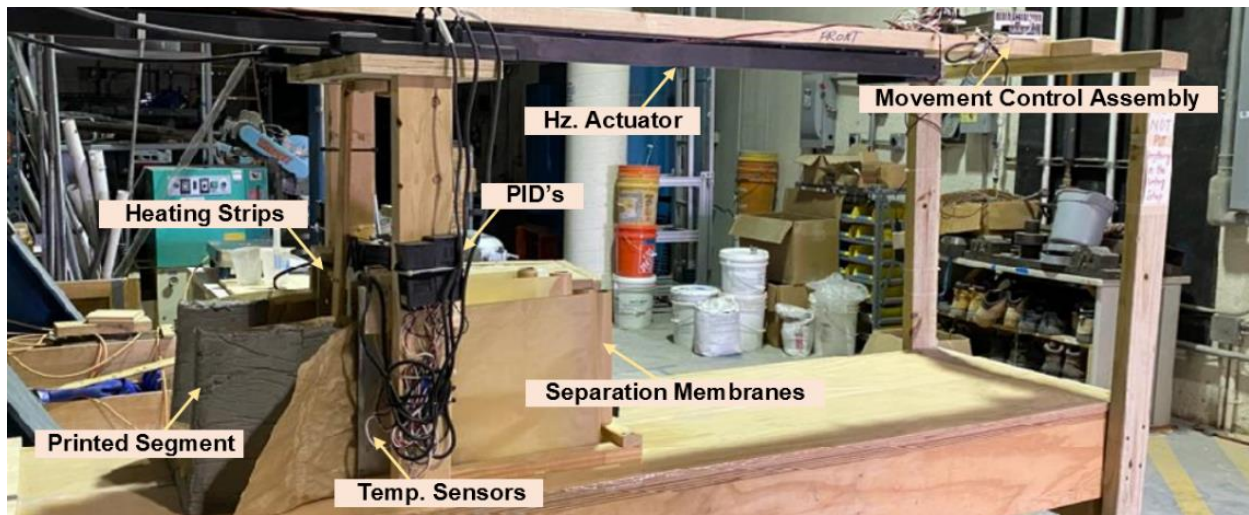

**Figure 8:** 3D printing assembly



**Figure 9:** 3D printed beam section

#### **Task 4– Experimental Testing for Large Specimens**

In this task, the beam specimen of UHPC shell using robotic construction will be tested under a 3-point load test setup. A similar specimen constructed using conventional method will also be tested under a 3-point load setup.

*Progress: This task is 100% complete. The reinforcement for both 3D-printed beam shell specimen and corresponding specimen with the conventional construction is shown in **Figure 10**. These specimens were tested for three-point loading to check their flexure behavior. The testing setup is shown in the **Figure 11**.*



**Figure 10:** Reinforcement a) 3D-printed beam shell b) Corresponding conventional concrete beam



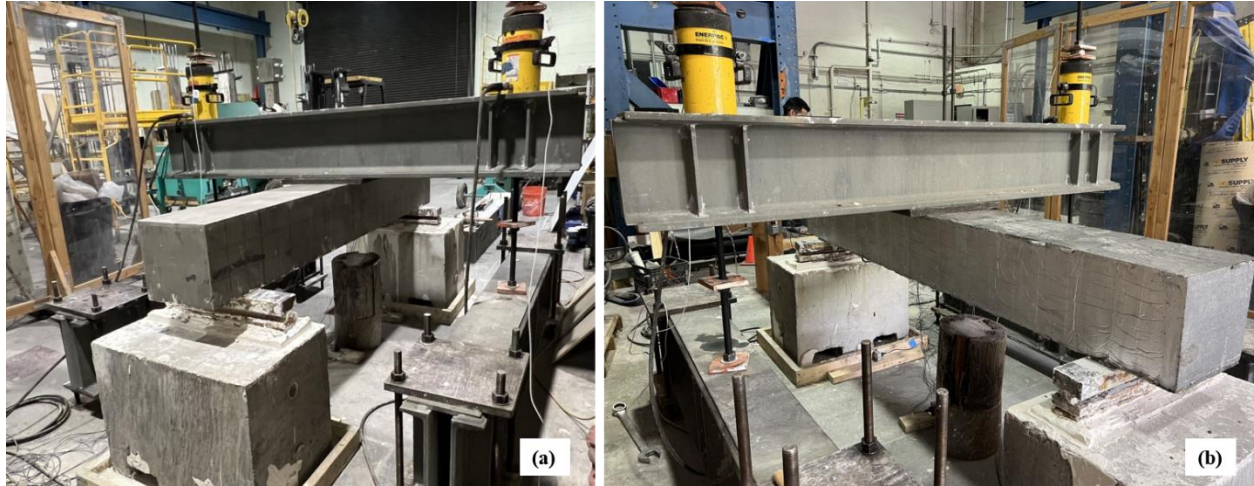
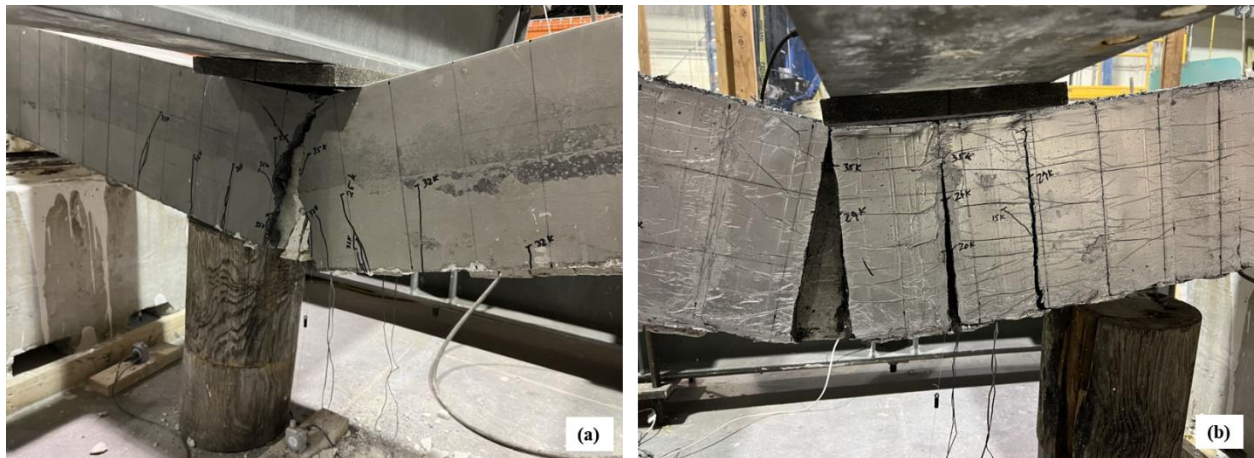

**Figure 11:** Three point loading testing setup a) 3D-printed beam shell b) Corresponding conventional beam shell

### **Task 5– Comparative Study between Conventional Construction and Robotic Construction Including Contracting**

In this task, the response of both specimens will be compared to similar specimens which were fabricated using conventional construction. In addition, contracting methods will be studied to help constructor on facilitating this proposed automated construction technique.

*Progress: This task is 60% complete. The tests have already been conducted on both specimens. The deformed shape of both specimens is shown in **Figure 12**. The analysis of results is being done.*



**Figure 12:** Failure pattern a) Conventional beam shell b) 3D-printed beam shell

### **Task 6- Final Report**

Final report will summarize the findings of this proposed research.

*Progress: The research team submitted a journal article to Transportation Research Record (TRR) which was published in the journal and presented in the virtual TRB 2021. The report of the project is under progress and will discuss the findings of this research.*

## 5. Schedule

Figure 13 shows the progress of the project.

Item	% Completed
Percentage of Completion of this project to Date	100%

Research Task	2021												2022											
	J	F	M	A	M	J	J	A	S	O	N	D	J	F	M	A	M	J	J	A	S	O	N	D
Task 1 - Verification of Exploratory Phase Results	Proposed	Proposed	Proposed	Proposed	Proposed	Completed	Completed	Completed	Completed	Completed	Completed	Completed												
Task 2 - Robotic Construction for Material Testing						Proposed	Proposed	Proposed	Proposed	Proposed	Proposed	Proposed												
Task 3 - Robotic Construction for Large Scale Specimens										Proposed	Proposed	Proposed	Proposed	Proposed	Proposed	Proposed	Proposed	Proposed	Proposed	Proposed	Proposed	Proposed	Proposed	
Task 4 - Experimental Testing for Large Specimens																								
Task 5 - Comparative Study between Conventional Construction and Robotic Construction Including Contracting																								
Task 6 - Final Report																								

■ Proposed  
■ Completed

Figure 13: Project flowchart.